

Tests

I. Air Travel



Johnny was making his first plane flight. The plane was up about 5,000 metres when the pilot sent it into a nose dive; it was headed straight for the city below. Pulling out of the dive, the pilot turned to Johnny and laughed:

"I bet fifty per cent of those people down there thought we were going to crash."

"Yes," said Johnny, "and I'll bet fifty per cent of the people up here thought so, too."

*

Air Hostess: "You'll have to change twice, in Frankfurt and in New York, before you get to Los Angeles."

Hick From The Country: "Goodness me! And I've only brought the clothes I'm standing up in!"

1. AIR TRAVEL. Match the names with the pictures.

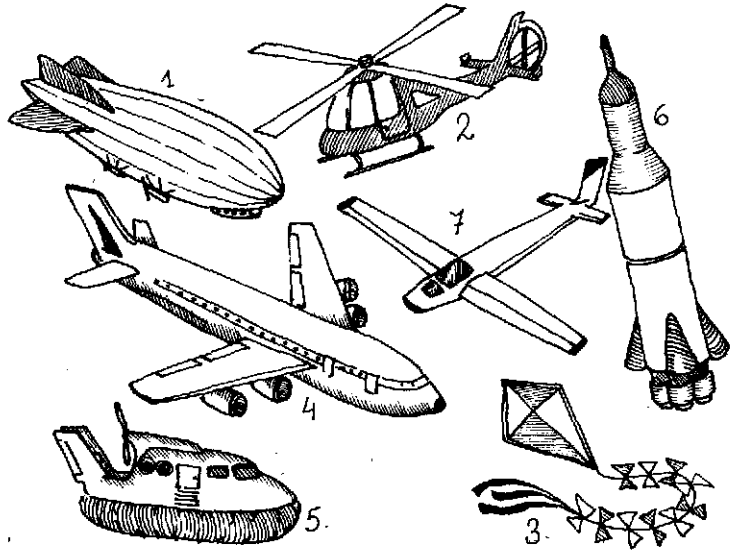

- | | | | |
|----------------|-------------|---------------|----------------|
| ... airliner | ... airship | ... glider | ... helicopter |
| ... hovercraft | ... kite | ... spaceship | |

2. AIR TRAVEL. Choose the correct answer.

- The plane circled over the airport until the was clear.
a) highway b) landing c) runway d) terminal
- All flights in and out of the airport came to a because of the strike.
a) closure b) conclusion c) standstill d) stoppage
- If you carry too much luggage, the airline will charge an baggage fee.
a) additional b) excess c) extra d) over
- British Airways the departure of Flight 222 to Warsaw.
a) advertise b) advise c) announce d) notice
- When you get to the airport, your luggage will have to be
a) balanced b) estimated c) sealed d) weighed
- Because of the fog, our flight was from Heathrow to York Airport.
a) deflected b) diverted c) replaced d) reverted
- The check time at the airport was eight o'clock.
a) by b) in c) out d) up
- The from the airport was very tiring as we had to drive through the fog.
a) crossing b) flight c) ride d) voyage
- It's very strange but I had a(n) that the plane would crash.
a) intuition b) omen c) prediction d) premonition

10. It takes a while to to your surroundings after a long flight.
a) adjust b) balance c) fit d) settle
11. Much stricter must now be taken at all airports against hijacking.
a) alarms b) precautions c) protections d) warnings
12. The air hostess told the passengers to their seat belts.
a) attach b) fasten c) fix d) tie
13. To fly big passenger airliners long training and experience.
a) calls for b) orders c) picks up d) requisitions
14. The plane was towards the runway when the fire started.
a) heading b) landing c) sailing d) soaring
15. The from Warsaw to New York takes nine hours.
a) flying b) journey c) passage d) voyage
16. I'm afraid your luggage is ten kilos ; you will have to pay extra.
a) above b) excess c) heavy d) overweight
17. A passenger is not allowed to a lethal weapon when flying by a civilian airliner.
a) be having b) be owning c) carry d) control
18. Nobody that aeroplane crash.
a) died b) lived c) recovered d) survived
19. Our was delayed owing to bad weather conditions.
a) airline b) airway c) flight d) runway
20. When our flight was delayed, we all had a meal at the airline's
a) account b) cost c) expense d) finance
21. Please, from smoking until the plane is airborne.
a) exclude b) refrain c) restrain d) resist
22. We to announce a further delay in the departure of flight BE-555.
a) apologise b) mourn c) regret d) repent
23. Tickets booked on this flight are not
a) assignable b) moveable c) passable d) transferrable
24. If you want a cheap air ticket you must well in advance.
a) book b) buy c) engage d) reserve
25. He couldn't his fear of flying.
a) overcome b) succeed c) triumph d) win
26. The stewardess the screaming child.
a) corrected b) cured c) recovered d) soothed
27. It was a great to go up in a helicopter for the first time.
a) incident b) rise c) suspense d) thrill
28. Nothing could me to fly except in a case of extreme emergency.
a) encourage b) induce c) influence d) recommend

3. AIR TRAVEL. Answer the clues. The number of letters is given.

- | | | | |
|----|-------|-------|-------|
| | 1 | A | _____ |
| | 2 | _____ | l |
| 3 | _____ | R | _____ |
| 4 | _____ | - | _____ |
| 5 | _____ | T | _____ |
| 6 | _____ | R | _____ |
| | 7 | A | _____ |
| | 8 | V | _____ |
| 9 | _____ | E | _____ |
| 10 | _____ | L | _____ |

1. an area of land where aircraft can land and take off, be kept, repaired, etc. (7)
2. a trip by aeroplane, especially carrying passengers on a regular service (6)
3. a member of the cabin staff who looks after the passengers' needs (7)
4. the act of leaving the ground by an aeroplane (7)
5. a person who flies an aeroplane; captain (5)
6. a big building where planes are kept (6)
7. the act of coming down onto the ground again from the air (7)
8. the science or practice of flying (8)
9. all the people working on an aeroplane (4)
10. a plane without an engine (6)

** 4. PARTS OF THE AIRCRAFT. Match the indicated parts of the aircraft with their names.

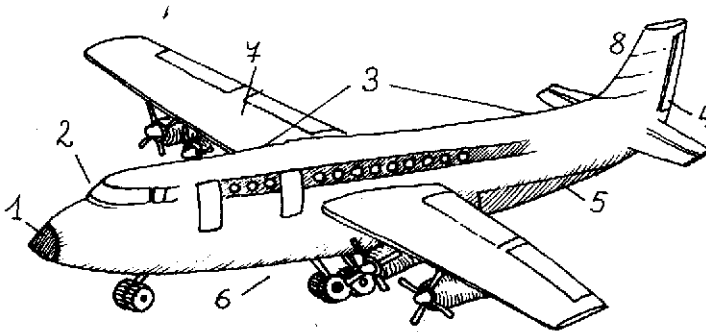

- | | | | |
|-------------|------------|-------------------|-----------|
| ... cockpit | ... fin | ... fuselage | ... hatch |
| ... nose | ... rudder | ... undercarriage | ... wing |

5. AIR TRAVEL. Put each of the following words or phrases into its correct place in the passage below.

air vents	cabin	captain	carry
co-pilot	crew	cruising speed	distances
flight	flight engineer	galley	jet-propelled
passenger	passenger list	safety belts	seats
size	tourist	stewardesses	take-off
trip			

Airliner

Airliners, or planes, differ from light planes not only in but also in speed and equipment. They are designed to a greater number of people over longer without stopping to refuel.

A passenger airliner has a comfortable with soft carpets, adjustable upholstered, washrooms, and individual and reading lights. It has a for preparing food. Many airlines offer, or economy class service, which costs less than first-class travel.

The of four-engine airliners range from about 350 mph for propeller-driven planes to more than 500 mph for planes.

The of an airliner works as a team to make the trip smooth and pleasant. While the passengers take their seats, the pilot or, co-pilot, flight engineer, and stewardesses prepare the plane for The pilot, assisted by the, checks the instruments and tests the controls. The checks the other mechanical equipment. The stewardesses check the, make sure that the passengers fasten their for Later, the distribute magazines, serve meals, and do other things to make the enjoyable.

XI. Houses and Homes

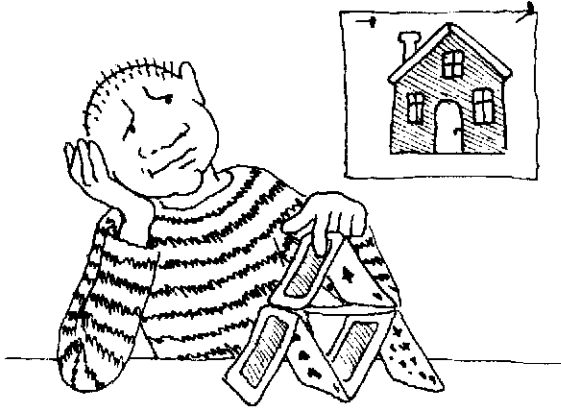

“We are living in a better neighbourhood now.”

“So are we.”

“Have you moved, too?”

“No. We’re still living in the same block you moved away from.”

*

“I knew an artist once who painted a cobweb on the ceiling so realistically that the maid spent hours trying to get it down.”

“Sorry, dear, I just don’t believe it.”

“Why not? Artists have been known to do such things.”

“Yes, but not maids!”

225. PLACES TO LIVE. Write the number of each drawing next to the correct word.

- bungalow
- block of flats
- caravan
- castle
- cottage
- detached house
- houseboat
- lighthouse
- mansion
- palace
- semi-detached house
- tent
- terraced house
- windmill



226. PLACES TO LIVE. *Choose the correct answer.*

1. They live in a(n) house which stands by itself in a field.
a) attached b) detached c) detaching d) semi-detached
2. Having made his fortune he now in great luxury in a large house in the country.
a) dwells b) inhabits c) leaves d) lives
3. My brother lives on the eleventh floor of that of flats.
a) block b) building c) house d) tower
4. His house is nothing out of the , it's just an average four-roomed house.
a) normal b) ordinary c) typical d) usual
5. Going down the street, she walked past a long of houses, all exactly alike.
a) queue b) rank c) row d) train
6. In the village he was looked up to as the lord of the
a) castle b) fortress c) manor d) tower
7. He keeps all his tools and do-it-yourself equipment in a in the garden.
a) barn b) hut c) shed d) stable
8. Our house isn't joined to the other houses in the street: it's
a) attached b) disconnected c) detached d) divided
9. The new police station is to be built the main square.
a) close b) near c) neighbourhood d) side
10. I am staying in a youth in the centre of the town.
a) hostel b) inn c) pub d) stable

227. PLACES TO LIVE. *What sort of people would you expect to find living in the following?*

- | | | |
|-------------|---------------|--------------|
| 1. barracks | 5. an inn | 9. a shanty |
| 2. a hotel | 6. lodgings | 10. a tent |
| 3. a hovel | 7. a mansion | 11. a wigwam |
| 4. an igloo | 8. a tenement | |

228. PLACES TO LIVE. *Complete each of the following sentences with an appropriate word for a type of building.*

1. He is a real prince and his family has lived in this _____ t _____ since the 14th century.
2. The high _____ y _____ in New York are mostly to be found in the central part of Manhattan.
3. Students can save money and make friends by living in a university _____ t _____.
4. An elderly person is better off in a _____ a _____ with no stairs to climb.
5. I've always dreamed of moving to the country and living in an old _____ t _____.
6. The student's room was so untidy it was like a p _____.

7. When he was set free after twenty years in _____ s _____, he was amazed at the changes he found.
8. They don't live in a house, they live in a modern _____ c _____ of _____.
9. A family house standing on its own is called a _____ c _____ house.
10. He keeps his tools and equipment in a _____ he has put up in his garden.

229. PLACES TO LIVE. *Fill in the right word.*

1. This small cottage is _____ u _____ example of the local architecture of the 16th century. All the other buildings in the neighbourhood date from at least one hundred years later.
2. Originally this building was d _____ n _____ as a hotel. It was only after its construction began that they decided to turn it into a college.
3. The street was so narrow that she could not park her car. She had to park it on the _____ m _____ in front of the building.
4. They live outside the town centre in a little house in the _____ u _____.
5. We love our old house so much that we never want to _____ to a new one.
6. Many new apartments have been built in our neighbourhood. Our little old house is now s _____ n _____ by monstrous sky-scrapers.

230. KINDS OF HOUSING. *Put each of the following words or phrases into its correct place in the passage below.*

above	apartments	between	buildings
cities	communities	duplex	expensive
families	floors	homes	land
large	less	quarter	row
side	single	single-family	stores
suburban	wall		

Kinds of Housing

About two-thirds of the _____ in the United States live in single-family _____. About a _____ of the families live in _____ that have two to four _____, or in _____ or other commercial buildings that include apartments.

_____ cities have more apartment housing than small _____, because _____ is scarce and _____. Small towns and _____ areas, where land is _____ expensive than in city centres, have mostly _____ homes.

Philadelphia and other _____ have many _____ houses. These are usually single-family houses, one or two _____ high, standing _____ to wall. A _____ is a building with two apartments, either _____ by side with a _____ wall _____ them, or one _____ the other.

231. KINDS OF HOUSING. *Where do these people live or where might they be living at the moment?*

- | | |
|---|---------------------|
| 1. campers | _____ t |
| 2. holiday-makers who find hotels too expensive | g _____ h _____ |
| 3. a king | _____ c _____ |
| 4. monks | _____ n _____ |
| 5. nuns | _____ n _____ |
| 6. cowboys | r _____ -h _____ |
| 7. foresters in deep woods | (l _____ -) c _____ |
| 8. old people without families | o _____ 's h _____ |
| 9. skiers in the mountains | ch _____ |

232. HOUSES: BUILDING, REPAIRING OR BUYING. *Choose the right answer.*

- They bought the land with a to building a new office block.
a) goal b) purpose c) reason d) view
- Nowadays builders must get from the planning authorities before putting up a new house.
a) allowance b) freedom c) liberty d) permission
- Before you take the job on, would you give me a rough of how much it will cost?
a) estimate b) esteem c) value d) worth
- An architect planning a new house should always in mind his client's needs.
a) bear b) carry c) take d) train
- He gave some very advice on buying a house.
a) dear b) precious c) valuable d) wealthy
- The fire officer is coming to the building tomorrow.
a) inspect b) look c) watch d) witness
- They decided to down their original plans for the house and make it smaller.
a) change b) climb c) play d) scale
- In response to our advertisement, two couples are coming to over the flat tomorrow morning.
a) get b) look c) run d) pass
- Though badly damaged by fire, the palace was eventually to its original splendour.
a) renewed b) renovated c) repaired d) restored
- The house is part of his from his aunt.
a) heritage b) inheritance c) testament d) will

233. STAGES IN BUILDING A HOUSE. *Put these stages in the right order and then match them with the expressions on the left.*

- | | |
|-------------------|---|
| 1. First, | a. the drains are dug. |
| 2. Then, | b. the materials are bought. |
| 3. Meanwhile, | c. the house is painted. |
| 4. Subsequently, | d. the walls are built. |
| 5. At this stage, | e. the site is purchased. |
| 6. Next, | f. the site is levelled. |
| 7. Afterwards, | g. the foundations are laid. |
| 8. Then, | h. the house is ready to live in. |
| 9. Later, | i. the roof is put on. |
| 10. Eventually, | j. the doors and windows are put in. |
| 11. Finally, | k. the electricity and water systems are installed. |

234. HOUSES: BUILDING, REPAIRING OR BUYING. *Choose the right answer.*

- We are going to our house by building another room on to it.
a) develop b) extend c) spread d) stretch
- The charged by the architect for the plans of the new building were unusually high.
a) fees b) hire c) price d) sum
- The agents didn't letting all the new flats before the block was completed.
a) bargain b) expect c) foresee d) suspect
- The outside the house said: "PRIVATE".
a) advice b) label c) notice d) threat
- The of the house were dug in June and the roof was on by December.
a) basements b) ground floors c) scaffolds d) foundations
- When you build a house you must start by laying the
a) attic b) basement c) cellar d) foundations
- The house is old and it's in bad
a) condition b) damage c) situation d) state
- She was keen to the house to its original condition.
a) rebuild b) renew c) renovate d) restore
- We could have provided him with a detached house but he asked for a small flat.
a) decidedly b) solely c) specifically d) strongly
- The best person to approach if you are house-hunting is an estate
a) agent b) clerk c) official d) representative

* 235. **BUYING A HOUSE.** Put each of the following words or phrases into its correct place in the passage below.

buyer	contract	deposit
document	fixtures	information
lawyer	legal	possession
price	proof of ownership	property
purchaser	seller	signs
terms	time	

Buying a House

When a has chosen the house he wants, he has a draw up a contract. This states the definition of the , gives the purchase , and demands from the present owner. It also includes other important , such as the that are to remain in the house and the when the will take

The buyer pays a when he the The deposit binds the to the of the contract.

* 236. **BUYING A HOUSE.** Choose the right answer.

1. He refused to sell his house at the low offered.
a) expense b) figure c) money d) sale
2. There has been a in the sales of new houses since mortgages became more difficult to obtain.
a) broke b) crash c) dive d) drop
3. All their money is up in the new house they have bought.
a) connected b) limited c) lying d) tied
4. The of two houses proved such a financial burden that they were forced to sell one.
a) upkeep b) uproar c) upshot d) upsurge
5. I am not prepared to sell you my house unless you offer a more price.
a) actual b) correct c) realistic d) true
6. When my grandfather died, his house was put up for
a) auction b) bargain c) offer d) market
7. He bought his house on an plan, paying a certain amount of money each month.
a) instalment b) part c) piece d) share
8. Before you agree to buy that house, find out if the Building Society will give you a
a) credit b) deposit c) loan d) mortgage
9. His solicitor advised him to make sure that the house was fully by insurance.
a) covered b) defended c) guarded d) protected
10. The corrupt real-estate agent wanted to obtain the contract so he offered a to the civil servant.
a) bait b) bonus c) bribe d) tip

**** 237. BUYING A HOUSE.** Rewrite the following advertisement in its full form.

Mod. det. hse., immac. cond. Fhld. 3 gars. 5. beds., 3 receps., 2 fully tiled baths. + sep. wcs; lge. fit. kit. 18 × 9 ft., dble sink; lux. lnge. Gas CH/chw; dble. glaz. Curts., fit. cpts. included. Landscd. gdn., swim. pool. Few mins., stn., bus, amens., seafront. \$ 150,000 ono.

238. BUYING A HOUSE/FLAT. Choose the correct answer.

1. They sold their house for only \$ 15,000, so the buyer got a wonderful
a) amount b) bargain c) cost d) worth
2. If we want to buy a house, we'll have to our spending.
a) care for b) cut back c) let down d) save
3. The rise in house prices him to sell his house for a large profit.
a) achieved b) enabled c) managed d) succeeded
4. They me a good price for my house, so I sold it.
a) brought b) offered c) showed d) suggested
5. All house-owners need policy against thefts or accidents.
a) an assurance c) an insurance c) a protection d) a security
6. I advise you to take to ensure that your property is adequately covered by insurance.
a) actions b) dealings c) means d) steps
7. They great difficulty saving up enough money for a house.
a) achieved b) found c) had d) made
8. He bought that house, that he would inherit money under his uncle's will.
a) accounting b) assuming c) considering d) estimating
9. They made of over \$ 1,500 on the sale of their house.
a) a benefit b) a gain c) a fall d) a profit
10. He was lucky to get the house for less than the asking
a) amount b) cost c) price d) value
11. This house has been up sale for over a year now.
a) at b) for c) in d) to

239. RENTING A FLAT. Choose the correct answer.

1. The only of the flat is that it's a bit too small.
a) complaint b) disadvantage c) mistake d) sorry
2. They are going to ask the landlord to their rent.
a) drop b) leave c) lessen d) lower
3. The flat we have rented is very for the train station.
a) comfortable b) convenient c) near d) suitable

4. I would love to have a house , but for the time being I must rent this flat.
a) by my own b) for my own c) of my own d) to my own
5. Our main concern is to raise the lodgers' of living.
a) capacity b) conditions c) degree d) standard
6. Students in hostels are to keep their rooms clean and tidy.
a) desired b) expected c) hoped d) wanted
7. Are you going to your flat in Cracow while you are abroad?
a) dispose b) hire c) let d) sale
8. He asked if we would to share the room.
a) accept b) agree c) approve d) consider
9. The for the flat is \$ 70 a week.
a) due b) fee c) hire d) rent
10. We are into our new flat next week.
a) arriving b) entering c) moving d) transporting
11. The tenants were not to disturb other tenants after 11 p.m.
a) appaled b) demanded c) desired d) requested
12. Could we both stay at your flat? Have you got enough ?
a) area b) place c) room d) space
13. My landlady doesn't me to have parties.
a) agree b) allow c) appreciate d) approve
14. When the owner let the flat to me I signed a(n) that I would leave at the end of June.
a) advice b) agreement c) bargain d) insurance
15. a flat with someone is cheaper than living on your own.
a) Dividing b) Halving c) Parting d) Sharing
16. Your new flat me very much of the one we had in London.
a) recalls b) recollects c) remembers d) reminds
17. The of newcomers to longstanding residents is very high in this block of flats.
a) average b) cross-section c) percentage d) proportion
18. I should like to rent a flat; modern, comfortable and in a quiet position.
a) above all b) after all c) before all d) over all
19. The room was noisy and not very for studying.
a) fitted b) matching c) proper d) suitable
20. Many accidents in the home could be if householders gave more thought to safety in their houses.
a) avoided b) excluded c) preserved d) protected

**** 240. RENTING A FLAT.** Rewrite the advertisement in its full form.

A lux. s/c sgl. furn. gdn. flt. 1 rm., k. & b. C.H.

Cpts., Col. T.V., tel., fridge, ckr., h/c.

\$ 180 p.m. Refs. reqd.

Avail. mid. Apr.

Tel: 01-678-1234 Evgs after 7.

241. RENTING A FLAT. Choose the correct answer.

1. Some of the people living on the Council's new estate decided to set up a(n) association.
a) dwellers' b) football c) inhabitants' d) tenants'
2. There are several landlords approved by the university who take in
a) inhabitants b) lodgers c) residents d) settlers
3. The landlord requires a \$ 50 from tenants to cover possible damage.
a) bail b) deposit c) security d) tip
4. My landlady has recently signed an agreement renewing my for the next four years.
a) occupation b) possession c) residence d) tenancy
5. They the advantages and disadvantages of moving and finally decided against it.
a) asked themselves b) weighed up c) meditated d) thought
6. Having decided to rent a flat, we contacting all the accommodation agencies in our city.
a) set about b) set off c) set out d) set to
7. The Housing Committee has decided to give to young married couples with children.
a) preferment b) presentation c) prestige d) priority
8. Homeless families the empty houses and started to renovate and redecorate them.
a) homed b) moved c) squatted d) tenanted
9. When the landlord died all the sitting tenants were given notice to
a) depart b) disappear c) leave d) quit
10. The landlord them because they hadn't paid their rent for three months.
a) demolished b) dismissed c) evicted d) threw out

*** 242. RENTING A FLAT.** Choose the right answer.

1. The scarcity of housing accommodation means that people can no longer afford to where they live.
a) buy and sell b) come and go c) look and see d) pick and choose
2. Considering how few services we get, the rates we pay are
a) daylight robbery b) down to earth c) out of this world d) peanuts

3. The squatters are fighting and nail not to be evicted from the houses they have occupied.
 a) finger b) hammer c) toe d) tooth
4. He lives a(n) throw from the station.
 a) apple's b) arrow's c) knife's d) stone's
5. You've managed to find a cheap flat near Picadilly Circus. you!
 a) Happy b) Fortunate c) Lucky d) Merry

243. PARTS OF A HOUSE. *Write where you would expect to find the following rooms in a house and what they would normally be used for.*

- | | |
|------------------|------------------------|
| 1. attic | 5. lavatory/toilet/loo |
| 2. basement | 6. loft |
| 3. cellar | 7. lounge |
| 4. larder/pantry | 8. study |

*** 244. PARTS OF A HOUSE.** *Match the definition with the correct part of a house.*

- | | |
|--------------------|--|
| 1. alcove | a. windows made up of two panes of glass instead of one |
| 2. attic | b. the half-pipe along the edge of the roof to carry away rainwater |
| 3. chimney | c. a small space in the form of a small room added to another room for a bed, books, etc. |
| 4. cellar | d. a window in the roof |
| 5. central heating | e. used in modern houses instead of open fires |
| 6. double glazing | f. the space at the top of the stairs |
| 7. French windows | g. a roofed entrance built onto a house |
| 8. hall | h. doors made of glass which usually open out onto the garden |
| 9. guttering | i. a hall or corridor, not a room, which leads from the entrance to the rooms inside a building |
| 10. landing | j. the wide passage just inside the entrance of a house off which the rooms open |
| 11. lobby | k. a room immediately below the roof of a house |
| 12. lounge | l. a hollow passage often rising above the roof of a building which allows smoke and gases to pass from the fire |
| 13. niche | m. an underground room, usually used for storing goods |
| 14. porch | n. a comfortable room for sitting in |
| 15. skylight | o. a hollow place in a wall, usually made to hold an ornament, books, etc. |

* 245. PARTS OF A HOUSE. Indicate the following parts of a house on the drawing below.

alcove	attic	chimney	cellar
French windows	guttering	skylight	porch

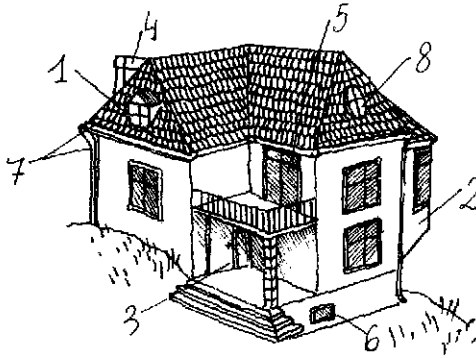

246. PARTS OF A HOUSE. Choose the correct answer.

- A row of trees the house from the north wind.
a) fence b) prevent c) shelter d) warn
- The house is old and it's in bad
a) condition b) damage c) situation d) state
- Many old houses have an underground room called a(n)
a) attic b) cave c) cellar d) loft
- People were strolling under the trees on either side of the broad through the park.
a) alley b) avenue c) path d) track
- His flat is in the
a) basement b) cellar c) ground d) lift
- He hung up his overcoat in the as soon as he came into the house.
a) attic b) cellar c) hall d) loft
- The shop had on the door but it was closed.
a) available b) free c) open d) vacant
- Some town children had never seen grass or trees and could play only in a small between their houses.
a) field b) garden c) park d) yard
- There was a magnificent drive which round to the front of the mansion.
a) arched b) bent c) curved d) inclined
- Three stone lead up to the front door.
a) levels b) stairs c) stones d) steps
- It is a large building, on six , and many families live there.
a) flats b) floors c) stages d) stairs
- The from the gate to the cottage was overgrown with weeds.
a) passage b) path c) road d) street

13. The hall seemed lit after the bright sunshine outside.
 a) dimly b) faintly c) slightly d) vaguely
14. Their office of four small rooms.
 a) consists b) contains c) includes d) numbers
15. He went down to his workshop in the
 a) annexe b) basement c) ground floor d) loft
16. In this part of the country, the fields are separated by stone
 a) barriers b) fences c) hedges d) walls
17. My address is 52 Long Street, and I live on the
 a) basement b) cellar c) ground floor d) foundations
18. Their flat is on the top
 a) attic b) floor c) loft d) store
19. They have a tennis at the bottom of their garden.
 a) court b) field c) ground d) pool
20. We haven't got a garage, so we leave our car outside in the
 a) drive b) garden c) pavement d) porch

247. PARTS OF A HOUSE. *Write in which room you would look for the following people.*

- | | | | |
|--|---|---------|--------------|
| 1. an artist | a | __ t | _____ |
| 2. a corpse | a | m | _____ |
| 3. a football player after the match | a | ch | _____ - room |
| 4. a gardener in winter | a | g | _____ |
| 5. a novelist | a | s | _____ |
| 6. a patient before an appointment | a | _____ | room |
| 7. a photographer developing pictures | a | _____ k | _____ |
| 8. a pilot while flying | a | c | _____ t |
| 9. a prisoner | a | _____ l | _____ |
| 10. some off-duty soldiers | a | m | _____ |
| 11. some workers during their lunchbreak | a | c | _____ |
| 12. some teachers between lessons | a | s | _____ |

*** 248. PARTS OF A HOUSE.** *Choose the right answer.*

1. The smell of the dirty alley drove us away.
 a) foul b) grimy c) polluted d) squalid
2. He waited in the for the front door to open.
 a) crypt b) inlet c) porch d) threshold
3. Although most of the rooms are small, the hall is
 a) abundant b) extended c) spacious d) tiny

4. The of the roof kept the rain off better.
a) climb b) flow c) plane d) slope
5. The villa has excellent for cooking and for washing clothes.
a) amenities b) conveniences c) facilities d) utilities
6. In the old house he had to bend down to avoid hitting his head on the
a) beams b) bearings c) props d) supports
7. The kitchen was small and so that the disabled woman could reach everything without difficulty.
a) compact b) complete c) complex d) contained
8. The only way to see into the basement room was by peering through the at the bottom of the wall.
a) drain b) fanlight c) grating d) skylight
9. The built onto the back of the house provided valuable extra space.
a) development b) enlargement c) extension d) growth
10. In the room resembles the letter L.
a) figure b) form c) pattern d) shape

249. HOUSES. *Fill in the right words.*

1. My landlord has decided to increase my _____ next year.
2. Leave your umbrella in the stand in the _____.
3. The main _____ n _____ was locked so they had to use the _____ door.
4. Our flat is in very poor shape now. Last time we had it _____ c _____ was ten years ago.
5. It was very cold in the _____ r _____ so she covered her sleeping daughter with an extra blanket.
6. If you want the estate agent to sell the house for you, you'll have to let him see the d _____ s that show you're the legal owner.
7. It was very stuffy in the room and the air was difficult to _____ t _____.
8. I expected my husband to come home late, therefore I left the door _____ k _____.
9. "Would you like to take a _____?" "No, thanks, I've just had a shower."
10. _____ on the door before you come into the room!
11. Your room is a terrible _____! Clean it up at once!
12. In Britain a home loan is usually referred to as a m _____.
13. Our children no longer sleep in the same room. They have _____ r _____ bedrooms now.
14. We were all at home last night sitting watching television in the _____ u _____.
15. I put an _____ d _____ for a flat in the newsagent's window, but I haven't had any replies yet.

250. HOUSES. *Choose the right answer.*

1. The street lamps are switched on automatically at
a) dark b) dusk c) evening d) sunrise
2. His bedroom the park.
a) overlooks b) oversees c) overtakes d) undergoes
3. The bright colour of the woodwork rather from the quiet beauty of the house.
a) contracts b) detracts c) distracts d) extracts
4. The old houses were down to make way for a block of flats.
a) banged b) hit c) knocked d) put
5. My house is very for getting to work as it is only a few minutes from the station.
a) convenient b) fit c) suitable d) useful
6. There were so many new buildings in the town that she hardly the place.
a) distinguished b) identified c) made out d) recognised
7. It is only a small flat but it my needs perfectly.
a) fills b) fits c) settles d) supplies
8. We are into our new house on Monday.
a) arriving b) entering c) moving d) transporting
9. This house has only been since last summer.
a) dwelled b) lived c) occupied d) resided
10. Just looking at the room you would have no idea of the real purpose it
a) filled b) served c) took d) used
11. They've finally decided to that lovely old house on the hill.
a) appoint b) preserve c) renew d) renovate
12. In recent years there has been a(n) increase in the cost of living.
a) important b) powerful c) significant d) wide
13. The Newrichs have just bought a beautiful house in the country.
a) aged b) ancient c) antique d) old

251. HOUSES. *Give a synonymous word for the capitalized expression.*

1. For a moment we sat **WITHOUT ANY LIGHT AT ALL**.
For a moment we sat in complete
2. **HOW LONG** is the new pitch?
What is the of the new pitch?
3. It took us about an hour to **GET ALL THE GOODS OFF** the lorry.
It took us about an hour to the lorry.
4. He pays **A LOT OF MONEY FOR HIS FLAT**.
He pays a high for his flat.
5. We live in a **RESIDENTIAL DISTRICT AWAY FROM THE CENTRE OF TOWN**.
We live in a

*** 252. HOUSES.** *Choose the right answer.*

1. Greg is in the garden, chopping for the fireplace.
a) forests b) trunks c) twigs d) wood
2. It was very in the cottage with the comfortable armchairs by the fire.
a) easy b) gratifying c) refreshing d) snug
3. In spite of the thunderstorm, the children slept all night.
a) noisily b) roundly c) resonantly d) soundly
4. Do open the window; this room seems very
a) breathless b) mouldy c) rancid d) stuffy
5. Believing herself alone in the house she was when she heard someone moving about in the hall.
a) amazed b) annoyed c) incredulous d) startled
6. He took out a big of keys, and opened the door.
a) branch b) bunch c) group d) packet
7. The children round the fire to keep warm.
a) cloistered b) grouped c) huddled d) tucked
8. The of the family home following the divorce was a great shock to the children.
a) break-down b) break-in c) break-out d) break-up
9. The house looked in the failing evening light.
a) austere b) lucky c) severe d) strict
10. I have lived near the railway for so long now that I've grown to the noise of the trains.
a) accustomed b) aware c) familiar d) unconscious

253. FURNITURE AND FITTINGS. *Choose the right answer.*

1. Some rooms don't have curtains at the windows, they have
a) blinds b) carpets c) gates d) stores
2. When Madeleine lost her front-door , she went straight to the police-station.
a) bolt b) fastener c) key d) lock
3. I was so tired last night that I fell asleep the moment my head touched the
a) bed b) blanket c) cushion d) pillow
4. It was on the top shelf, out of
a) achievement b) attempt c) reach d) touch
5. It was very dark in the cellar so he a match.
a) rubbed b) scraped c) scratched d) struck
6. What a beautiful ! It's a pity we don't have any flowers to put in it.
a) crystal b) cup c) glass d) vase
7. The house is quiet because the carpets are so
a) fat b) heavy c) smooth d) thick

8. It was difficult to see anything because the lights were so
a) dim b) dull c) faded d) weak
9. The table was a curious as both the top and the legs were curved.
a) form b) model c) pattern d) shape
10. Have you got a in your bag? It's so dark here that I can't even see the path.
a) bulb b) candle c) lantern d) torch
11. She closed the windows and drew the before switching on the light.
a) coverings b) curtains c) masks d) shades
12. One end of his single room was used as a kitchen but this was hidden behind a
a) blind b) screen c) shield d) veil
13. When she cleaned the high windows, she always stood on a three-legged
a) bench b) chest c) ladder d) stool
14. They us how to work the machine.
a) begged b) demonstrated c) explained d) showed
15. Please wipe your feet on the door- before you come in.
a) blanket b) mat c) rug d) tile
16. You shouldn't leave your bicycle outside in the rain. It will get.
a) broken b) muddy c) oxidised d) rusty
17. The old lady managed to climb the which was narrow but not all that steep.
a) degree b) ladder c) scale d) staircase
18. The vacuum cleaner is a valuable labour-saving for the busy housewife.
a) device b) engine c) instrument d) piece

254. FURNITURE AND FITTINGS. THE LIVING ROOM. Give the names of the indicated items of furniture.

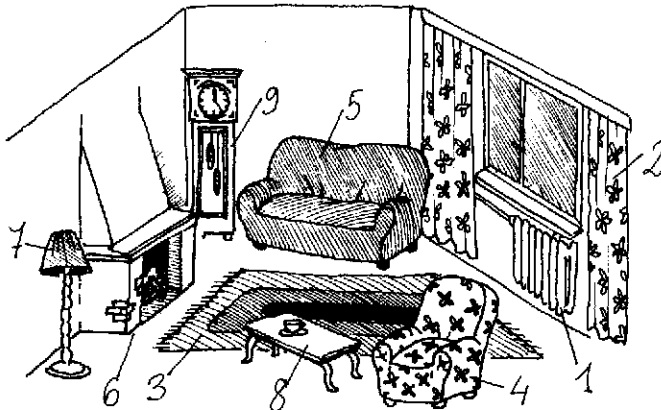

- | | | |
|------------------|--------------------|------------------|
| 1. r _____ | 2. _____ t _____ s | 3. _____ p _____ |
| 4. _____ c _____ | 5. s _____ | 6. _____ l _____ |
| 7. _____ s _____ | 8. c _____ t _____ | 9. _____ |

255. FURNITURE AND FITTINGS. *Choose the right answer.*

1. She couldn't see herself in the mirror because of the rising from the hot bath.
a) fog b) mist c) smoke d) steam
2. Her room is comfortable but rather on the small
a) angle b) basis c) side d) size
3. This chair looks very to our old grey one.
a) exact b) familiar c) like d) similar
4. There were four chairs in the living room, one in each
a) corner b) edge c) side d) wall
5. This beautiful wardrobe has been in our family for over two centuries and is now very
a) dear b) expensive c) precious d) valuable
6. This table would nicely for Mary's room.
a) agree b) do c) fit d) suit
7. She wanted to remove the colour from the curtains so she them.
a) bleached b) dried c) dyed d) rinsed
8. It was a strange clock with an hour that was longer than the minute one.
a) finger b) hand c) needle d) rod
9. Whether or not you like some kinds of modern furniture is a matter of
a) comparison b) favour c) taste d) vogue
10. Be careful how you handle this vase as it is
a) invaluable b) priceless c) valueless d) worthy
11. The windows don't fit very well and it makes the room awfully
a) airy b) breezy c) draughty d) ventilated
12. Where do you your pencils? In this drawer?
a) close b) guard c) hold d) keep

*** 256. FURNITURE AND FITTINGS.** *Choose the right answer.*

1. Be careful going up the stairs, Ma. Hold on to the
a) banister b) edge c) railing d) side
2. If you have a new key cut, it must be an exact of the existing one.
a) counterfeit b) copy c) imitation d) model
3. The kitchen of the holiday cottage looked rather than beautiful.
a) mundane b) practicable c) utilitarian d) workable
4. They had four children so the new washing-machine was a great
a) advantage b) aid c) benefit d) boon
5. Mrs Elegant has had the couch in her sitting-room in red velvet.
a) clothed b) enriched c) sewn d) re-upholstered

6. The room was so with furniture that is was impossible to move.
a) assembled b) burdened c) cluttered d) overrun
7. Switch on the lamp, it casts a nice warm on the polished furniture.
a) beam b) glow c) sheen d) shine
8. The wind blew so hard and so strongly that the windows in their frames.
a) flapped b) rattled c) shocked d) slapped
9. Do you know that Mrs Impudent has bought curtain material exactly the same as ours.
She's a dreadful
a) ape b) copy-cat c) mocking bird d) parrot
10. You'd better pack those glasses extremely carefully if you want them to arrive
a) complete b) entire c) intact d) whole
11. It is advisable to pull down the when the sun is very hot.
a) blinds b) covers c) screens d) shutters
12. The drawer is You will have to get something to break it open.
a) fixed b) jammed c) loose d) rooted

257. FURNITURE AND FITTINGS. THE BEDROOM. Match each of the following names of items of furniture and fittings with the correct number in the picture.

- ... wardrobe
- ... pillow
- ... pillow-case
- ... sheet
- ... bedspread
- ... mattress
- ... bedside table
- ... dressing-table
- ... stool
- ... mirror
- ... chest-of-drawers
- ... rug

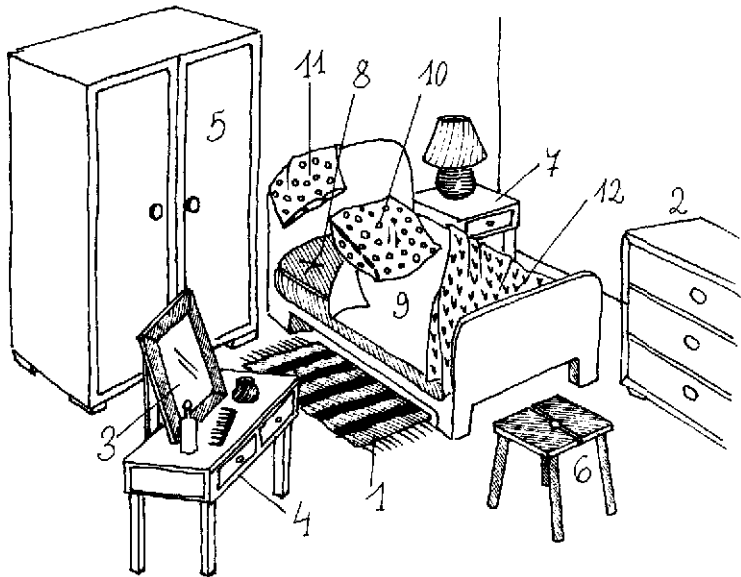

258. FURNITURE AND FITTINGS. *What would you expect to find in the following?*

- | | |
|-----------------------|----------------|
| 1. a bureau | 4. a safe |
| 2. a chest-of-drawers | 5. a sideboard |
| 3. a linen chest | 6. a wardrobe |

259. FURNITURE AND FITTINGS. THE BATHROOM. *Match each of the following names with the correct number in the picture.*

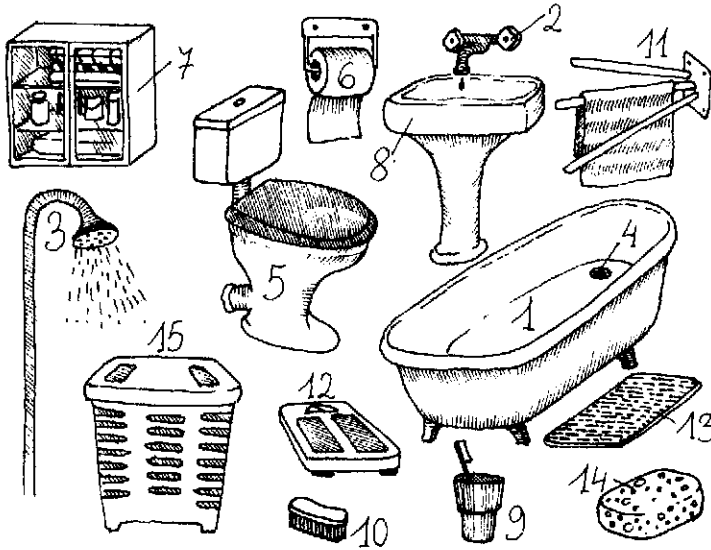

- | | | | |
|----------------------|--------------------|-----------------|----------------|
| ... bath | ... laundry-basket | ... shower | ... tooth-mug |
| ... bathmat | ... lavatory | ... sponge | ... towel rail |
| ... bathroom cabinet | ... nailbrush | ... tap | ... wash-basin |
| ... bathroom scales | ... plug-hole | ... toilet-roll | |

260. FURNITURE AND FITTINGS. *Arrange the following household contents under three headings:*

1. Furniture
2. Household appliances
3. Soft furnishings

- | | | | | |
|-------------|----------|--------------|-------------|----------------|
| bedding | chairs | dishwasher | sideboard | television |
| beds | cooker | freezer | tables | vacuum cleaner |
| bookshelves | curtains | refrigerator | tablecloths | wardrobes |
| carpets | cushions | rugs | telephone | |

*** 261. FURNITURE AND FITTINGS.** *Choose the best answer.*

- All the rooms have carpets, which are included in the price of the house.
a) adapted b) equipped c) fitted d) suited
- She read him a good-night story, him up and then kissed him and turned the light off.
a) fixed b) folded c) packed d) tucked
- The Palace offered a variety of riches: Persian rugs, marble tables, etc.
a) affluent b) opulent c) unsaleable d) wealthy
- Put the vase on the over the fireplace.
a) ledge b) mantelpiece c) sill d) step
- The children were sleeping in bed.
a) easily b) homely c) snugly d) softly
- Don't leave your coat on the chair, hang it on the behind the door.
a) bracket b) hook c) lump d) rod
- In the old days, curtains were hung over doors to keep out
a) breezes b) currents c) draughts d) gales
- The drawer is ; I shall have to try and open it with a knife.
a) bolted b) dislocated c) screwed d) stuck
- With its expensive furniture and carefully-chosen colour scheme the room looked
a) convenient b) homely c) luxuriant d) luxurious
- The room was of furniture.
a) absent b) devoid c) scanty d) scarce
- As Mary opened the door, the candle in the breeze and then went out.
a) flamed b) flickered c) sparkled d) twinkled
- There is no danger in using this machinery as long as you to the safety regulations.
a) abode b) adhere c) comply d) observe

262. FURNITURE AND FITTINGS. *Complete the following sentences.*

- I keep all my clothes in the bedroom in a big _____ r _____ .
- The silver _____ t _____ on the table were shining brightly because they reflected the flickering light of the _____ n _____ .
- It was a cold evening so I had a log fire going in the _____ r _____ .
- The most important thing about a house or flat is that it should be h _____ .
- My grandfather likes to sit in his favourite _____ c _____ , smoking his _____ p _____ .
- I thought these were real flowers, but they are _____ f _____ . They are made of plastic.
- In Cracow, in order to get RAIUNO reception, it's essential to have a proper a _____ .
- The _____ g _____ of this carpet is about 8 ft.

9. Although we now have eight chairs, I'm afraid this will not be _____ g _____ and some of our guests will have to sit on that old _____ t _____.
10. I eventually found the scissors I'd lost behind the chest of _____ w _____.
11. Our house has central heating, so every room has a _____ d _____.
12. Doors that go round and round are called r _____ doors.
13. It is very difficult nowadays to find cheap and comfortable a _____ n in Cracow.
14. Everything in my kitchen is stored away in _____ b _____.
15. A door swings on its _____ n _____.

263. OPERATING HOUSEHOLD APPLIANCES. *Choose the correct answer.*

1. When you turn off the TV, please pull out the , too.
a) block b) plug c) switch d) wire
2. The electricity failure is not dangerous. There is no need for
a) alarm b) cowardice c) dread d) scare
3. When you this red button, the machine stops.
a) hit b) lift c) press d) pull
4. He the tap but could get no water.
a) adjusted b) controlled c) opened d) turned on
5. Where is the book of for using this washing machine?
a) directives b) instructions c) orders d) regulations
6. Can you help me? I can't how to start this machine.
a) do in b) get on c) set down d) work out
7. Don't touch that wire or you may get an electric
a) attack b) current c) shock d) surprise
8. Mr Impatient kicked the washing machine to try to it work.
a) cause b) force c) get d) make
9. The door will open if you it hard.
a) hold b) knock c) push d) throw
10. You can get drinking water by turning this
a) knob b) pipe c) switch d) tap
11. He wanted a bath but couldn't find the
a) cork b) lid c) plug d) stopper
12. I the door-bell several times but there was no-one at home.
a) knocked b) pulled c) rang d) squeezed
13. Ms Forgetful can't use her hair-drier as she forgot to buy a for it.
a) pin b) plug c) socket d) switch
14. A food processor has become an indispensable piece of in the home.
a) device b) equipment c) gadget d) machine
15. Who's left the tap running? There's a of water on the floor.
a) bucket b) heap c) pool d) stain

* 264. **OUT OF ORDER.** Choose the right answer.

1. The bath water doesn't run away properly; I think the must be blocked.
a) conductor b) hole c) pipe d) tube
2. The tap was dripping because it needed a new
a) rubber b) stopper c) washer d) wringer
3. There is a lot of water on the floor. I think the washing machine must be
a) dropping b) leaking c) oozing d) seeping
4. Phone the ! Water is pouring down the stairs.
a) builder b) engineer c) piper d) plumber
5. We'll have to use the stairs as the lift is out of
a) function b) movement c) order d) practice
6. My washing machine has, so I'm going to the laundrette.
a) broken down b) gone out c) run down d) worn out
7. There is something with my TV. The picture won't come on.
a) bad b) missing c) unusual d) wrong
8. I can smell gas — there must be a somewhere.
a) break b) drip c) flow d) leak
9. He has a little next to his garage where he makes things for the house.
a) housework b) mill c) workhouse d) workshop
10. The central heating doesn't seem to be properly.
a) going b) performing c) warming d) working
11. When I turned on the switch, the lights
a) cracked b) expired c) fired d) fused
12. I can't open this case; the seems to be jammed.
a) bolt b) catch c) closing d) lock
13. He swatted a fly on the window and the glass.
a) broke b) cracked c) cut d) slashed
14. We shall have to have the deck-chairs repaired. The canvas has
a) broken b) burst c) cracked d) split
15. My binoculars were not actually broken, they just needed
a) adjusting b) curing c) mending d) repairing
16. Most of the machines are as a result of an electric breakdown.
a) disused b) idle c) out of work d) powerless
17. I think there is something wrong with my lamp. I a shock when I tried to switch it on.
a) got b) made c) suffered d) took
18. The water could not flow freely because the pipe was
a) blocked b) bolted c) loaded d) trapped
19. She keeps a supply of candles in the house in case of a power
a) absence b) cut c) lack d) shortage
20. I should like to point out that two months have since you promised to come and repair my television.
a) elapsed b) expired c) lapsed d) transpired

265. CONNECTORS. Match each of the following connectors with the correct number in the picture below.

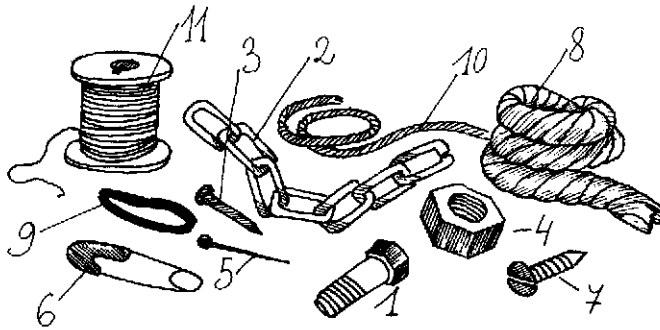

- | | |
|-----------------|----------------|
| ... thread | ... screw |
| ... chain | ... nut |
| ... string | ... safety pin |
| ... rope | ... pin |
| ... rubber band | ... bolt |
| ... nail | |

266. CONNECTORS. Crossword puzzle.

1	—	C	— — — —
2	—	O	— —
3	— —	N	—
4	—	N	— — — —
5	— — — —	E	— —
6	—	C	— — — — —
7	— —	T	—
8	—	O	— —
9	—	R	— — — — —
10	—	S	— — — — —

1. we use a screwdriver to put it on or take it out (5)
2. mountaineers use it to keep together and avoid falling (4)
3. it is used in dressmaking to hold pieces of cloth together (3)
4. we use a hammer to knock it into wood (4)
5. we use a needle to sew cloth with it (6)
6. it is made of iron and it is used to keep large ships in place in port (5)
7. it is made of metal and is used with 8. to keep different parts of machines together (3)
8. used with 7. to keep different parts of machines together (4)
9. to pin a notice to a notice board we use pins (7)
10. we tie up a parcel with it (6)

267. TOOLS. Match each of the following tools with the correct picture below.

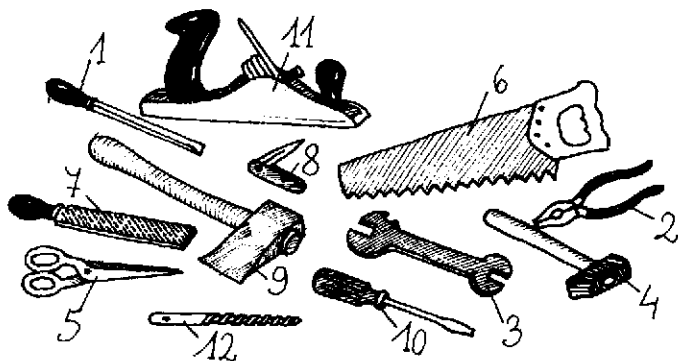

- | | | | |
|------------|-----------------|--------------|-------------|
| ... axe | ... chisel | ... drill | ... file |
| ... hammer | ... screwdriver | ... penknife | ... plane |
| ... pliers | ... saw | ... scissors | ... spanner |

268. TOOLS. Complete each of the following sentences with the name of a tool. Each dash (—) represents one letter.

- We cut down trees with an _____.
- We cut paper or cloth with a pair of _____.
- We knock nails into wood with a _____.
- We raise a car to change a wheel with a j_____.
- We put in and take out screws with a _____.
- We tighten or loosen nuts with a s_____.
- We saw wood with a _____.
- We bend and cut wire with p_____.
- We break up roads, rocks, etc. with a p_____.
- We draw corks out of bottles with a c_____.

269. TOOLS. Choose the right answer.

- I'll lend you my to chop down the tree.
a) axe b) jack c) saw d) spanner
- The screw on the cupboard seems to have worked
a) away b) loose c) unfixed d) unsteady
- I must cut this sheet of paper in two. Would you pass me the
a) axe b) chisel c) pickaxe d) scissors
- The axe left lying on a bench in the rain was now covered with
a) dirt b) dust c) mud d) rust
- Put some oil on that tight nut; that might the trick.
a) do b) make c) win d) work

6. These bolts are much too stiff to loosen by hand. Have you got a ?
a) jack b) key c) screwdriver d) spanner
7. What is the use of having a hammer, if you haven't any ?
a) bolts b) hooks c) nails d) screws
8. The simplest way to get this nut off the bolt would be to use a
a) chisel b) jack c) screwdriver d) spanner
9. A small is handy for minor electrical jobs in the home.
a) hammer b) nail c) screwdriver d) saw
10. He hammered a into the wall.
a) nut b) nail c) pin d) screw

270. HOUSEHOLD CHORES. *Choose the right answer.*

1. Granny is coming for lunch. Please the room before she arrives.
a) arrange b) order c) polish d) tidy
2. You shouldn't walk around with feet. The floor isn't very clean.
a) bare b) naked c) nude d) stripped
3. The attic was thick with as no one had cleared it for years.
a) dust b) powder c) rust d) sediment
4. Will you the beds at once! Our guests are at the door!
a) clean b) cover c) make d) smooth
5. The house felt cold and after weeks of bad weather.
a) damp b) moist c) watery d) wet
6. If you don't like washing up, you could into the possibility of buying a washing-up machine.
a) ask b) look c) order d) save
7. I must get to the laundry and my washing.
a) bring b) carry c) clean d) collect
8. Mrs Helpful has cleaned our house from to bottom.
a) attic b) first floor c) roof d) top
9. The only way to clean the box is to it in soap and warm water.
a) brush b) polish c) wash d) wipe
10. Don't forget to put the back on the toothpaste when you have finished with it.
a) cap b) cover c) hat d) lid
11. She has to work hard to keep the house and tidy with such a big family.
a) arranged b) neat c) ordered d) smooth
12. " your feet before you come into the house," cried Mrs Tidy.
a) Clean b) Polish c) Rub d) Wipe
13. Your for today is to do the washing up.
a) duty b) homework c) labour d) task

14. Ask your sister if she could give me with the washing up.
a) an aid b) an assistance c) a hand d) a help
15. They managed to get all their unwanted things at the jumble sale.
a) away with b) even with c) out of d) rid of
16. When you've washed up, the plates before you put them away.
a) clean b) dry c) dust d) sweep
17. It's your to clean the room; I did it last week.
a) occasion b) time c) try d) turn
18. the tube gently, so as not to waste the toothpaste.
a) Hit b) Lick c) Press d) Squeeze
19. Don't leave your coat lying on the sofa like that! Hang it up by the at the back of the collar.
a) band b) hole c) hook d) loop
20. Please close the window; there's a terrible
a) breeze b) current c) draught d) headwind

*** 271. HOUSEHOLD CHORES.** *Choose the correct answer.*

1. Her mother had asked her to do several before she went out.
a) jobs b) labours c) studies d) works
2. We had on the attic last weekend, and cleared out fifteen years' accumulation of odds and ends.
a) an attack b) a blitz c) an invasion d) a raid
3. There was a of rubbish in the corner of the bedroom.
a) dump b) mass c) pile d) stack
4. Mike picked up a and went out to clear the snow away from the front of the house.
a) fork b) jack c) rake d) shovel
5. Do straighten that picture over the fireplace, it looks from here.
a) bent b) crooked c) inclined d) uneven
6. It was cold enough for a fire so Mr Obedient went off to some wood.
a) chip b) chop c) crumble d) splinter
7. The drunken couple did nothing to keep the flat clean and tidy and lived in the utmost
a) contamination b) decay c) pollution d) squalor
8. I just have a few household to cope with and then I'll be able to rest.
a) assignments b) charges c) chores d) works
9. There must be something I can do to breaking your favourite tea-pot.
a) face up to b) go in for c) make up for d) put up with
10. He has a(n) habit of emptying ashtrays out of his window on to our doorstep.
a) disgusting b) offending c) uncultivated d) uneducated

*** 272. DECORATING. Choose the right answer.**

1. Before beginning to use the paint, you should it in the tin.
a) roll b) stir c) turn d) twist
2. Always wear goggles when spraying paint as a against damage to your eyes.
a) prevention b) refuge c) restriction d) safeguard
3. The house was built more than a hundred years ago. My father had it when he bought it.
a) altered b) changed c) renewed d) transformed
4. Changing the colour of the room seemed a good at the time, but they regretted it later.
a) belief b) idea c) opinion d) thought
5. This room looks terrible, it's in such a
a) disorder b) litter c) mess d) rubbish
6. I think the pattern on that wallpaper has been printed
a) back to back b) face down c) side to side d) upside down
7. The house is in good though it needs to be repainted.
a) condition b) position c) standing d) state
8. The colour of the handle does not so long as it is the right size.
a) affect b) concern c) matter d) worry
9. It's we did something about redecorating the sitting-room.
a) full-time b) good time c) high time d) long time
10. The floor was so rotten that it almost under his weight.
a) gave away b) gave back c) gave up d) gave way
11. The Bears have just had their sitting room
a) coloured b) dyed c) redecorated d) replaced
12. In my opinion, standards of workmanship have over the past ten years.
a) aggravated b) declined c) diminished d) eroded
13. Could you give me a rough of what the job might cost?
a) account b) correlation c) estimate d) value
14. My brother has just had central heating in his flat.
a) inlaid b) inset c) installed d) introduced
15. The storm a lot of houses in the village.
a) blew b) damaged c) disturbed d) drowned

*** 273. DECORATING. Choose the right answer.**

1. It took us only one day to the paper off all four walls.
a) chip b) paste c) scrape d) stroke
2. If you paint the walls cream, I think it will the colour of the curtains better.
a) bring out b) lift out c) make out d) take out

3. If the door has jammed, there's no point in trying to force it open. You'll only the handle off.
a) drag b) gouge c) pluck d) pull
4. If you want to change the colour of these walls, they will need at least two of paint.
a) coats b) coverings c) layers d) sheets
5. That door when you open it. You must put some oil on the hinges.
a) creaks b) rustles c) screeches d) shrieks
6. All the windows of the house were by the explosion.
a) crashed b) crushed c) shattered d) shredded
7. What a(n) colour that wallpaper is! Why ever did you buy it?
a) alarming b) bad c) dreadful d) frightening
8. That window needs a new of glass.
a) mirror b) oblong c) pane d) square
9. I think we should have glass put in the bathroom window. The people on the other side of the street can see right in.
a) cracked b) frosted c) patterned d) thick
10. The renovation work will closing the local library for at least two months.
a) accomplish b) ensure c) entail d) result
11. The firm deals more with decoration than building.
a) inside b) interior c) internal d) inward
12. Shall we off all this awful old wallpaper and paint the room instead?
a) rip b) scratch c) strip d) tear
13. The front door is in a terrible state; the paint is badly.
a) crumbling b) eroding c) flaking d) rotting
14. To my I noticed that the roof was leaning to one side.
a) consternation b) constitution c) constriction d) consumption

274. TOWNS AND VILLAGES. *Choose the right answer.*

1. I love to round the old part of the town, enjoying its peace and quiet.
a) rush b) sit c) tour d) wander
2. The town stands mainly on the left of the river.
a) bank b) cliff c) coast d) shelf
3. The farm area as far as the river.
a) advanced b) developed c) extended d) lay
4. The current of this town is about 350 000.
a) group b) membership c) number d) population
5. The hotel has been built on the of a lake.
a) border b) boundary c) edge d) front
6. Uncle Billy has bought a piece of near the sea and is going to build a house there.
a) country b) earth c) land d) territory

7. Our old house in a beautiful spot deep in the woods.
a) placed b) rested c) situated d) stood
8. They are going to build a big office block on that plot of land.
a) blank b) unusing c) vacant d) void
9. I'm glad I chose this part of town to live in. It's such a peaceful
a) environment b) neighbourhood c) proximity d) surroundings
10. There has been a lot of about the housing shortage in big cities.
a) advertising b) circulation c) communication d) publicity

275. TOWNS AND VILLAGES. *Fill in the sentences.*

1. Erie is the capital of the region. It is, in fact, the only _ _ j _ _ r city in this rural area.
2. _ _ r _ _ _ life is healthy and quiet when compared with life in cities.
3. The house stood by itself in the middle of fields. It was completely _ _ s _ _ _ _ _ _ _ _ .
4. Our city is situated on the west _ _ _ _ _ of the river.
5. Our house is rather difficult to find. I'll draw you a little _ _ _ _ _ to show you the way.
6. Last year we decided to move to the _ _ _ b _ _ _ _ _ as living here will cost much less than living in the centre of the town.
7. I'll always be a c _ _ _ _ _ person. I can't stand the noise and smell of the city.
8. I'm planning a month's walk through the Scottish c _ _ _ _ _ _ _ _ _ _ .
9. Farming here is very difficult because the _ _ i _ _ is very poor.
10. She has just bought a huge _ _ _ _ _ c _ _ of land to build her house on.

*** 276. TOWNS AND VILLAGES.** *Choose the right answer.*

1. Our village is ; some of the houses are very far apart.
a) diffused b) extended c) scattered d) spread out
2. Modern buildings should with the surrounding area.
a) blend in b) join in c) match d) suit
3. Since they built the car factory, a lot of new houses have in the district.
a) hopped up b) jumped up c) leapt up d) sprung up
4. The new town hasn't the usual yet, but a theatre, cinema and library are under construction.
a) aids b) amenities c) conveniences d) equipment
5. When the capital got too crowded, they had to build new towns to take the
a) overfill b) overrun c) overspill d) overstock
6. The monastery is on the of the town.
a) neighbourhood b) outskirts c) suburbs d) surroundings

- * 277. **TOWNS AND VILLAGES.** *Choose the word or phrase that best keeps the meaning of the original sentence if it is substituted for the capitalized word.*
1. The man was **RELUCTANT** to put in a few hours of work in the garden.
 - a) anxious
 - b) cager
 - c) negligent
 - d) unwilling
 2. At first it seemed that the building would be all right but later it was found to need **ALTERATIONS**.
 - a) beautification
 - b) decorations
 - c) modifications
 - d) restoration
 3. The picture is **ASKEW**; please straighten it.
 - a) adjustable
 - b) crooked
 - c) high
 - d) level
 4. There is a large area of **SWAMP** that will have to be cleared before construction can begin.
 - a) dry, sandy soil
 - b) forest
 - c) prairie
 - d) soft wet land
 5. The **STRAY** dog was picked up by the dog catcher because he had no collar.
 - a) dirty
 - b) homeless
 - c) sick
 - d) unfriendly
 6. He **TRAMPED** across the carpet in his boots, leaving a trail of mud behind him.
 - a) limped
 - b) skipped
 - c) walked heavily
 - d) walked unsteadily
 7. Do not leave the iron on that delicate fabric or the heat will **SCORCH** it.
 - a) burn
 - b) melt
 - c) press
 - d) wrinkle
 8. I would like your **PERMISSION** to trim that part of the tree that hangs into my yard.
 - a) approval
 - b) attention
 - c) encouragement
 - d) consent

9. The use of this product for building houses was recently **BANNED** by the Ministry of Health.
- backed
 - prohibited
 - sponsored
 - studied
10. Every year the average family discard about a ton of **TRASH**.
- filler
 - fuel
 - garbage
 - paper

278. TOWNS AND VILLAGES. Crossword.

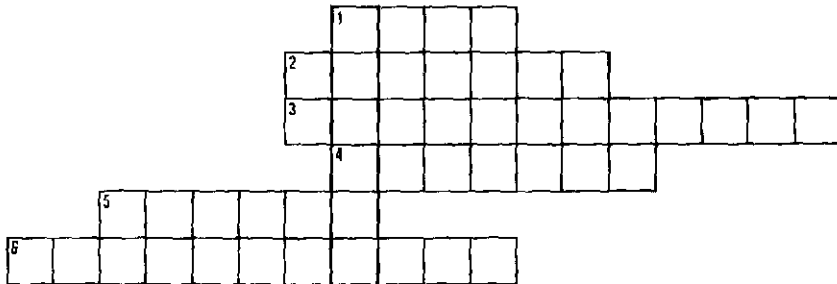

- place where your family lives (4)
- opposite of city (7)
- area near to or round a place (12)
- hills, trees, fields, etc. considered as things to look at (7)
- the world of animals, insects and plants (6)
- hills, trees, fields, etc. make this environment (11)

XVI. Sea Travel

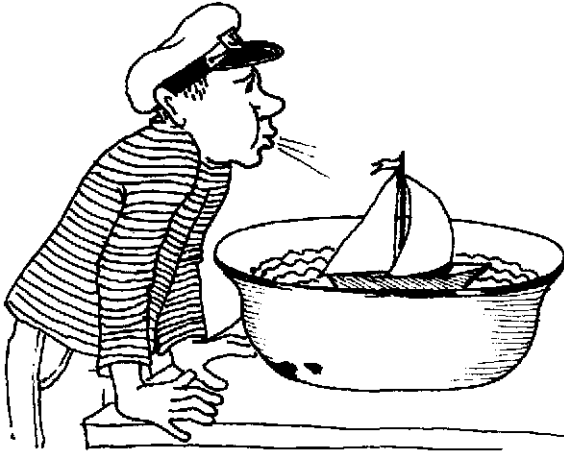

Sailor: "My word, but I'm thirsty."

Steward: "Wait a minute and I'll bring you some water."

Sailor: "I said thirsty, not dirty."

*

A sailor's enlistment in the navy expired. A friend asked him what he thought of the sea.

"Just this much," he said. "I'm going to put an oar over my shoulder and start walking inland — and I'm going to keep on walking and walking and walking until someone stops me and asks: 'What's that thing you've got over your shoulder?' Then I'm going to settle down right there until I die."

312. SHIPS AND BOATS. *Where would you be likely to see the following ships or boats?*

	river	canal	lake	sea	ocean	harbour	underwater
a barge							
a cargo boat							
a ferry							
a liner							
a rowing boat							
a submarine							
an oil tanker							
a yacht							

313. SHIPS AND BOATS. *Choose the correct answer.*

- The river is so here that you cannot use even a little boat.
a) flat b) narrow c) shallow d) straight
- In spite of the storm, the Captain the ship safely into port.
a) directed b) drove c) managed d) steered
- There was a toy boat floating on the of the water.
a) bottom b) flat c) surface d) upper
- He stood on the of the river, looking down into the water.
a) bank b) beach c) border d) coast
- Hold on to your lifebelt, otherwise you'll sink.
a) firm b) steady c) strong d) tight
- There was a terrible storm at sea last night and one of the boats
a) dived b) drowned c) floated d) sank
- The route into the harbour was marked by a line of
a) buoys b) compasses c) lightships d) signposts
- There were a number of fishing boats in the harbour.
a) attached b) fixed c) moored d) roped
- We're going to a cruise on the river next weekend.
a) go b) sail c) take d) travel
- The crew the sinking ship as fast as they could.
a) abandoned b) escaped c) quit d) surrendered
- Keep ! Don't panic! You will soon be rescued!
a) brave b) calm c) firm d) happy
- We have been unable to make with the ship by radio for the last two days.
a) communication b) connection c) contact d) link
- The old sailor away at his pipe, surrounded by a cloud of tobacco smoke.
a) blew b) gasped c) puffed d) snorted

314. SHIPS AND BOATS. *What are the following ships or boats usually used for?*

- | | |
|-----------------|------------------|
| 1. a barge | 5. a rowing boat |
| 2. a cargo boat | 6. a submarine |
| 3. a ferry | 7. a tanker |
| 4. a liner | 8. a yacht |

**** 315. SHIPS AND BOATS.** *Which of the following ships or boats would have funnels, guns, masts, oars, passengers?*

	funnels	guns	masts	oars	passengers
a barge					
a cargo boat					
a ferry boat					
a liner					
a rowing boat					
a submarine					
an oil tanker					
a yacht					

316. SHIPS AND BOATS. *Choose the correct answer.*

- Swimming across that river was a thing for him to do.
a) dangerous b) rough c) stormy d) violent
- I'm always seasick when the sea is
a) calm b) rough c) unsteady d) wild
- The "Anna Maria" from Gdańsk at 11:00 tomorrow.
a) embarks b) leaves c) sails d) steams
- The passengers amused themselves playing games on the upper of the ship.
a) deck b) dock c) floor d) platform
- We saw ships from all over the world in the
a) beach b) harbour c) pier d) shelter
- I don't want to go into the sea. I'd rather lie on the
a) bank b) beach c) coast d) seaside
- You must keep in the boat otherwise it will overturn.
a) balanced b) stiff c) still d) straight
- The boat turned over and sank to the
a) base b) basis c) bottom d) ground
- The ship's captain and members of the welcomed us on board.
a) cast b) crew c) staff d) team

10. In spite of the terrible storm, the ship was
 a) unbroken b) undamaged c) unhurt d) uninjured
11. During the twenty-day cruise, ten will be spent sea, and ten in port.
 a) at b) by c) in d) over
12. Although he shouted, his words were in the wind.
 a) drowned b) killed c) lost d) stopped

** 317. SHIPS. Match the indicated parts of the ship with the right names.

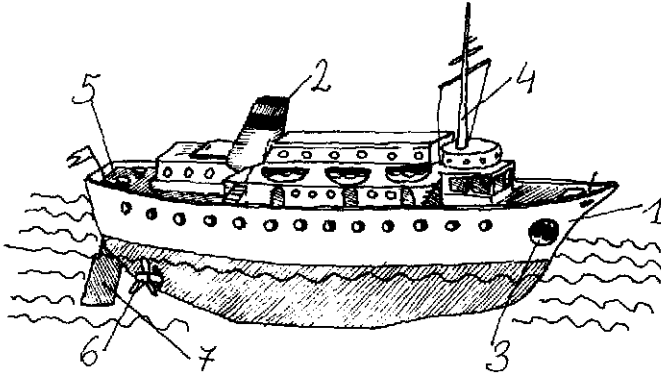

- | | | | |
|---------------|------------|------------|----------|
| ... anchor | ... bow | ... funnel | ... mast |
| ... propeller | ... rudder | ... stern | |

* 318. SHIPS AND BOATS. Choose the correct answer.

1. "Do you row?" "I used to, but I haven't used a pair of for years."
 a) oars b) paddles c) poles d) rows
2. The sea was so that some of the passengers in the pleasure boat felt seasick.
 a) breezy b) choppy c) runny d) wavy
3. They moored the boat to a tree and left it by the river bank.
 a) branch b) log c) pole d) stump
4. They loaded the for the voyage onto the ship.
 a) food b) meals c) portions d) rations
5. The ship ran on the beach near the harbour.
 a) aback b) adrift c) afloat d) aground
6. That boat has an motor at the back.
 a) outboard b) outgoing c) outside d) outward
7. At first sight the island seemed to be bare and of any kind of vegetation.
 a) absent b) devoid c) minus d) vacant

8. The captain realised that unless immediate action was taken to discipline the crew, there could be a on the ship.
a) mutiny b) rebellion c) riot d) strike
9. The cargo in the hold of the ship many times in the storm.
a) changed b) floated c) shifted d) switched
10. The sea is too far out; we can't swim till the comes in.
a) current b) stream c) tide d) water
11. A lot of driftwood was washed up on to the
a) coast b) coastline c) seaside d) shore
12. The sea was so rough that the little boat
a) bent b) capsized c) inverted d) reversed
13. When we go fishing we always take a lot of worms for
a) attraction b) bait c) food d) trap
14. Swimming is dangerous here because of the strong across the bay.
a) current b) jet c) motion d) pressure
15. The boat just out to sea.
a) drifted b) slid c) strayed d) wandered
16. After the storm the of a small ship was thrown up on the shore.
a) breakage b) ruin c) wastage d) wreckage
17. The ship was not allowed to unload its
a) burden b) cargo c) freight d) load
18. When the ship docked at Hamburg, they found a in the hold.
a) gate-crasher b) interloper c) stowaway d) trespasser
19. She was very enthusiastic about sailing around the world and now was just to go.
a) bounding b) leaping c) jumping d) roaring
20. I with the captain to abandon the ship before it was too late.
a) appealed b) begged c) claimed d) pleaded
21. Due to the bad weather conditions, the lifeboat crew were asked to in case of emergency.
a) stand away b) stand by c) stand in d) stand up
22. He had a escape when his boat was capsized by a sudden gust of wind.
a) close b) narrow c) near d) sudden
23. The waves gently against the shore.
a) bit b) chewed c) lapped d) licked
24. We managed to grab a piece of wood that was floating nearby and we hung on for life.
a) dear b) gentle c) kind d) precious
25. The air-sea search operation is continuing, although hopes of finding survivors are
a) dimming b) dissolving c) fading d) reducing

* 319. SHIPS. Choose from among the given vocabulary those related to the indicated subject. The list also contains all the vocabulary needed to fill in the blanks in the following exercise.

(to) board	bow	bunks	cabins	captain
charts	cliffs	coast	compass	cranes
crew	cruise	deck-chairs	docks	(to) embark
fleet	freighters	galley	gang-way	harbour
hold	knots	latitude	life-jacket	lighthouses
liner	loaded	mate	moored	(to) navigate
navigator	overboard	rope	rudder	seamen
seasickness	stern	stewards	stormy	vessels
voyage	waves	warships	wreck	

1. Which of the above are kinds of ships?
2. Which of the above are parts of a ship?
3. Which of the above are things found on a ship?
4. Which of the above are people found on a ship?

* 320. SHIPS AND SEA TRAVEL. Fill in the blanks in the following passages with vocabulary connected with ships and sea travel. Should you find it too difficult for you, see the vocabulary list in the preceding exercise.

Ships and Sea Travel

When a ship goes out to sea it leaves the , or port. The speed of a ship is measured in The foremost part of the ship is the The name of the ship is often painted on the back. This part of a ship is called the A is used to steer the ship. The goods are stored in the

The man in command on board is the The first is responsible for navigation. To a ship the sailors need maps, a and other instruments. Sea-maps are called A knows where they are at sea by finding the longitude and

All the people who work on board are Together they are called the of the ship. The crew sleep in , or berths.

A holiday-trip by ship is a When passengers go on to a ship we say that they , or board the ship. When you want to leave or the ship you have to use the gang-plank, or Holidaymakers on board can sit in They sleep in Passengers are served food by the The food is prepared in the

Sometimes the can be dangerous, especially when the coast consists of steep rocks called Along the more dangerous parts of the there are usually used for warning ships at sea.

If a ship runs into rocks, it becomes a If your ship is wrecked you have to jump Then you should wear a

When it's weather the surface of the water begins to move. These movements of the water are called When the waves are very high many people suffer from

Ships are and repaired in They are loaded and unloaded by Ships which carry cargoes are called and those which are used for war purposes are A ship which is part of a commercial is called a A general term for ships and boats is After a ship has sailed into the harbour it is This is mostly done with a or cable.